

FIG. 1

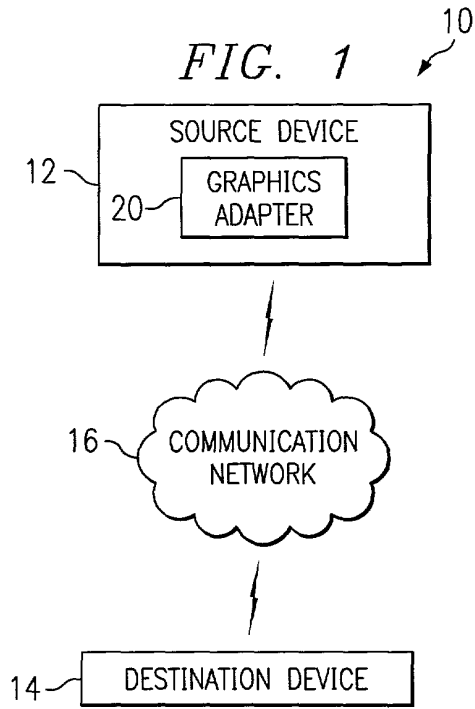
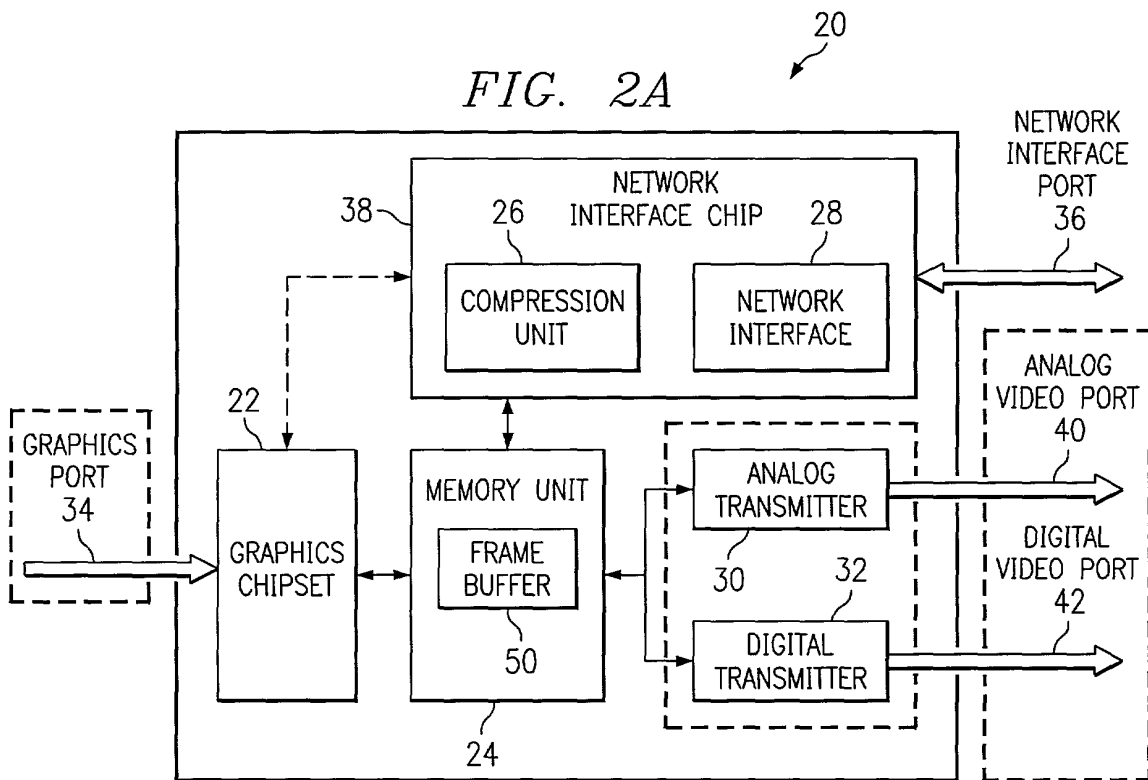

FIG. 2A



10017760-1

FIG. 2B

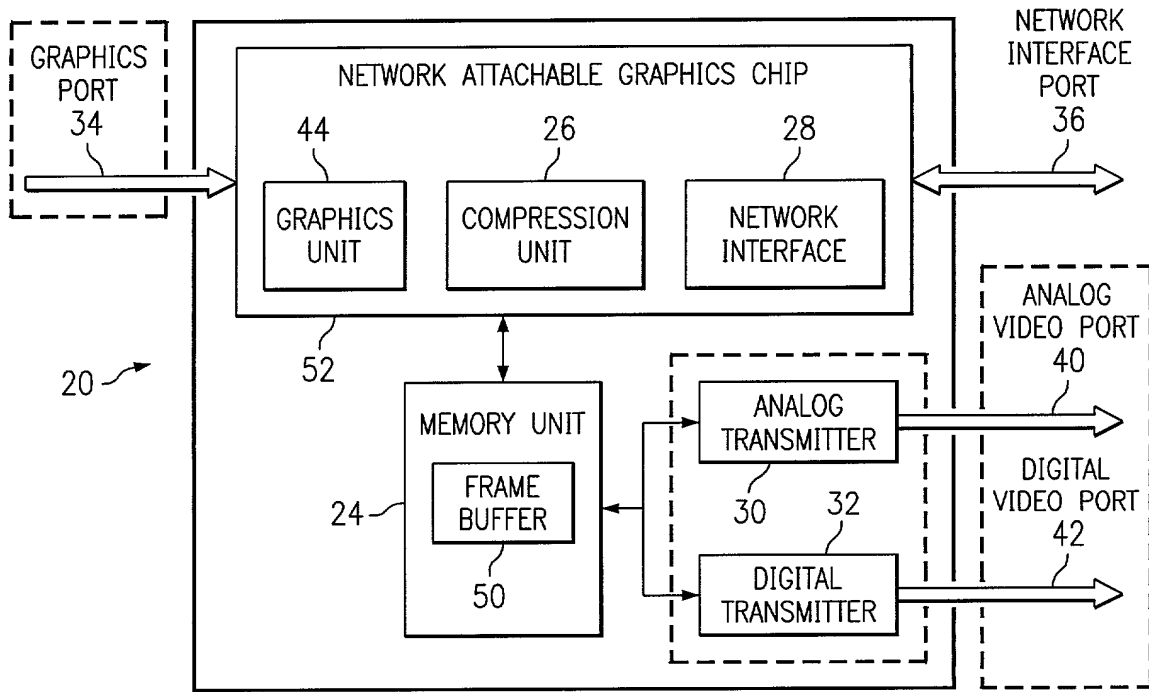

FIG. 3

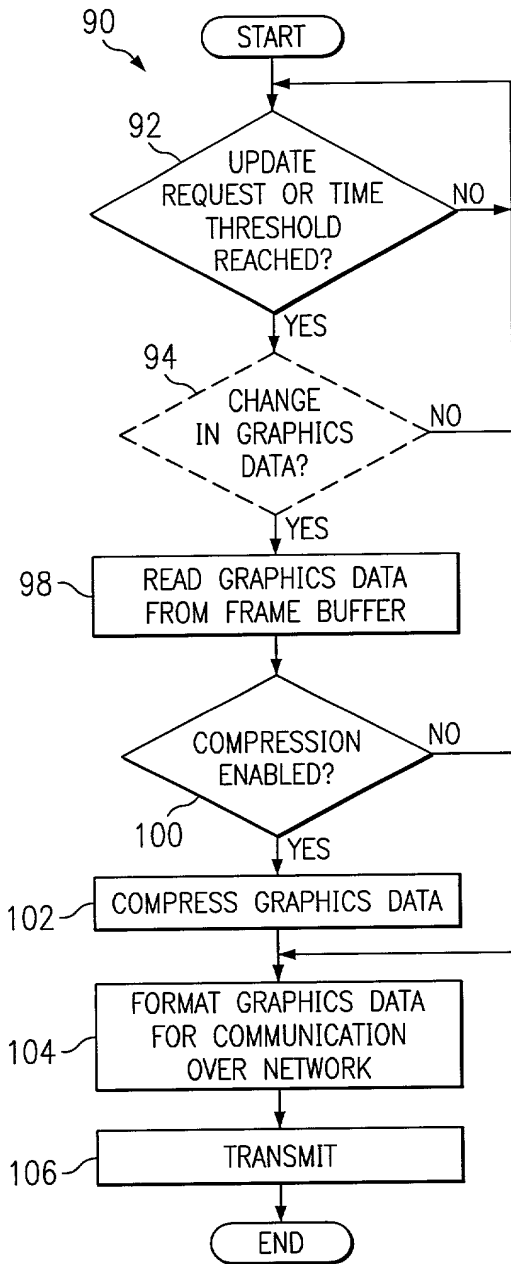
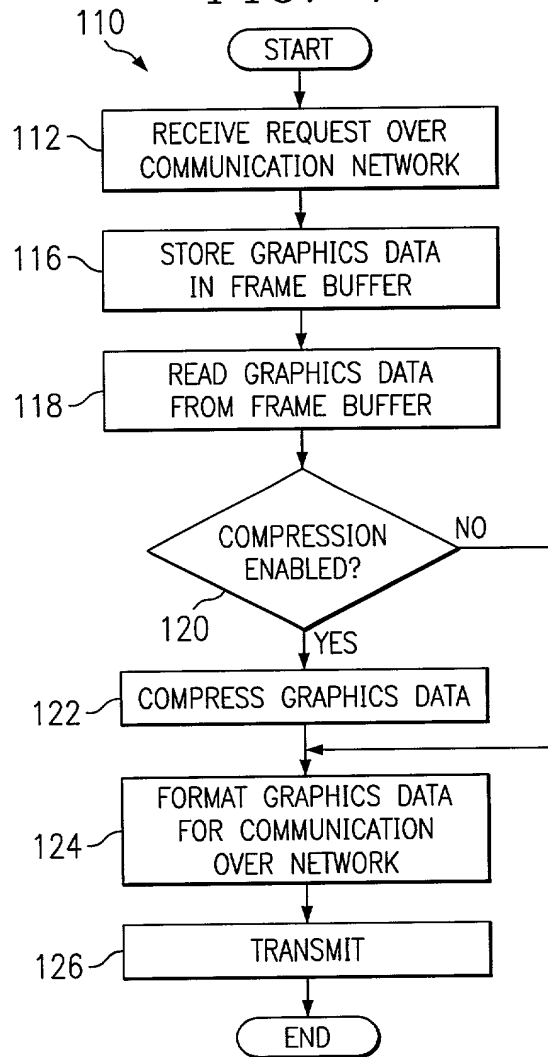

FIG. 4



10017760-1

FIG. 5

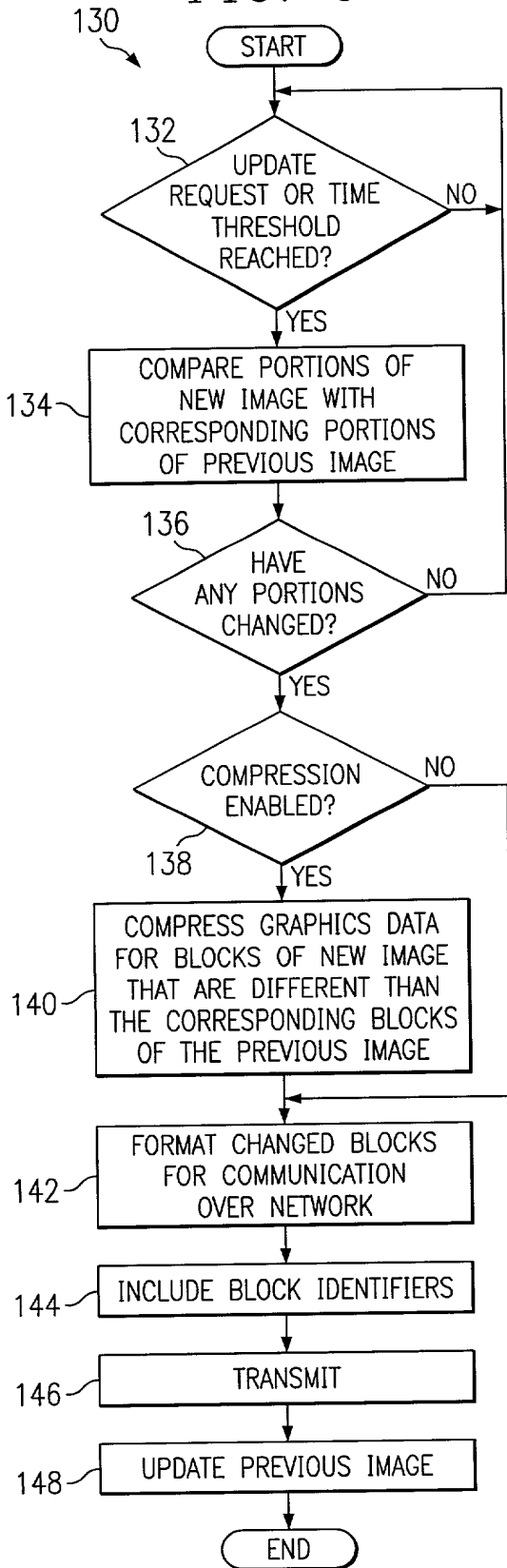
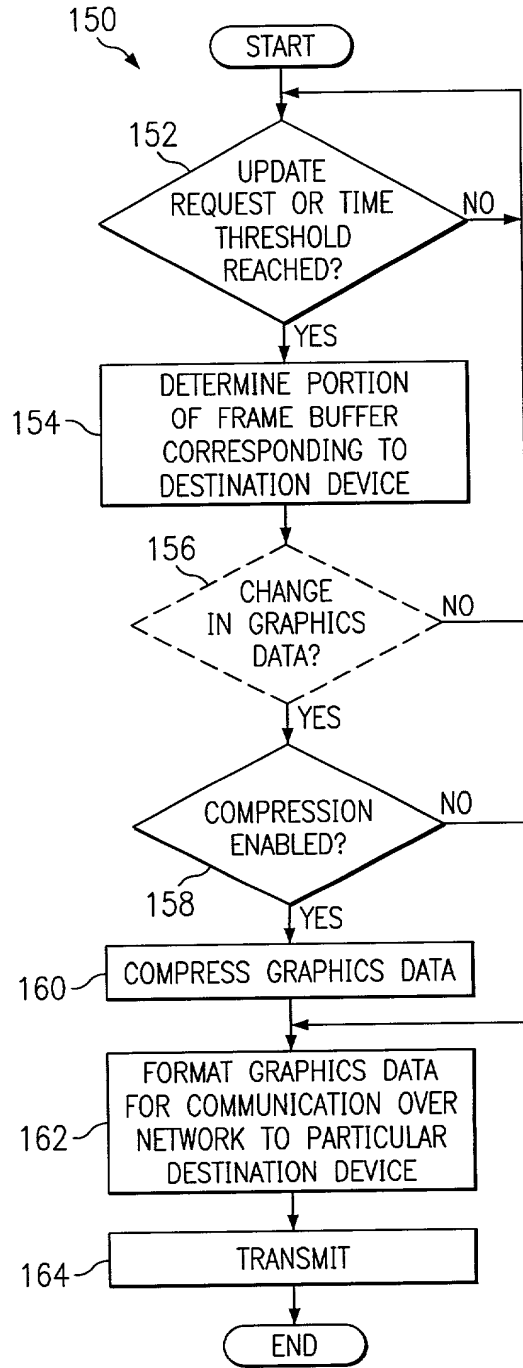

FIG. 6



Patent Application No. 10017760

FIG. 7A

14

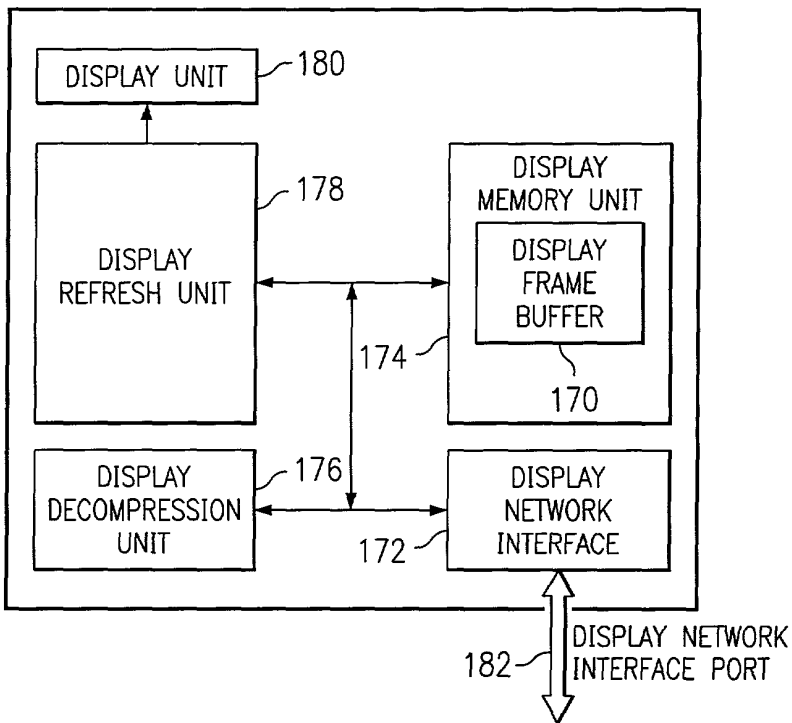
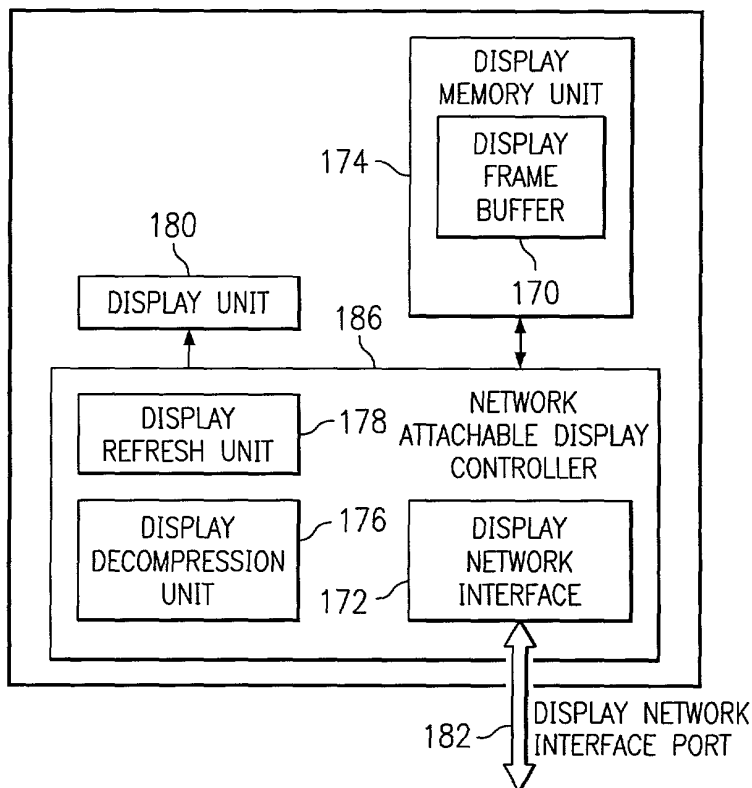
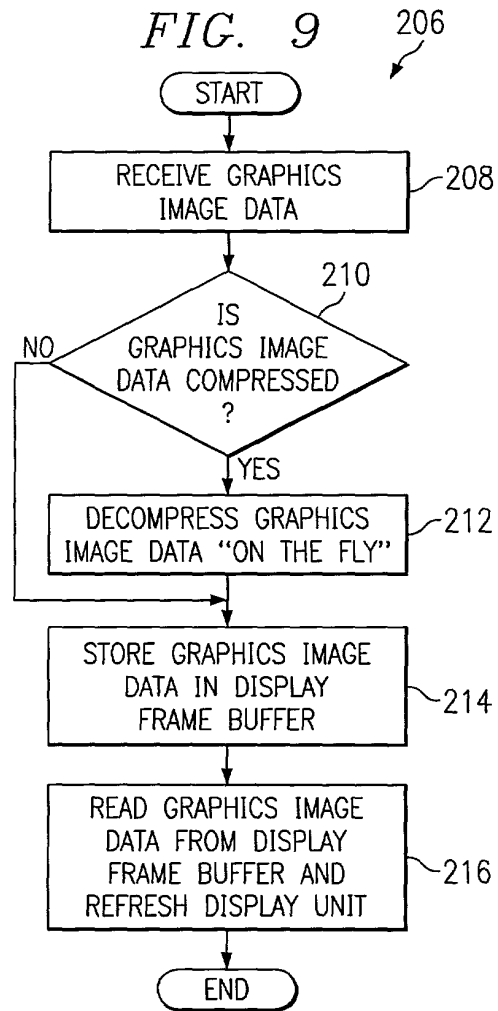
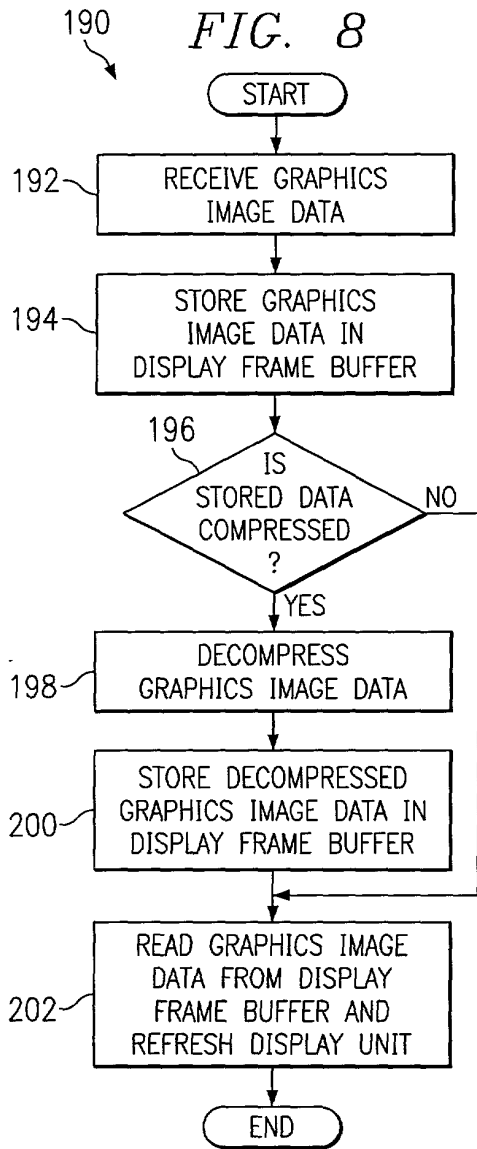

FIG. 7B

14





FOOTNOTES